

20 kN HKP/L Hand Aided Pneumatic Press

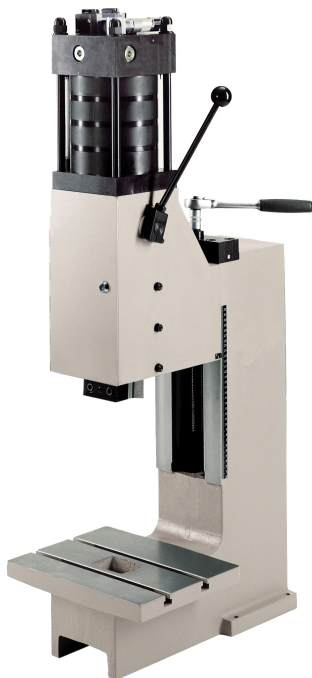

The BalTec 20kN HKP/L press is a robustly designed small press with lots of features.

- The ram is vee guided to ensure the ram does not rotate during use and also ensures accurate guidance
- The handle can be positioned anywhere over 360° for operator comfort
- The front spigot clamping block gives accurate all round clamping
- When the operator closes the toggle of the press the pneumatic cylinder will operate to complete the press stroke given 5.8mm of power stroke
- Large table with Tee slot clamping surface
- Quick and easy head height adjustment
- Also available as head only
- DXF, DWG and 3D Model files available on request
- Complies with CE standards without any additional guarding

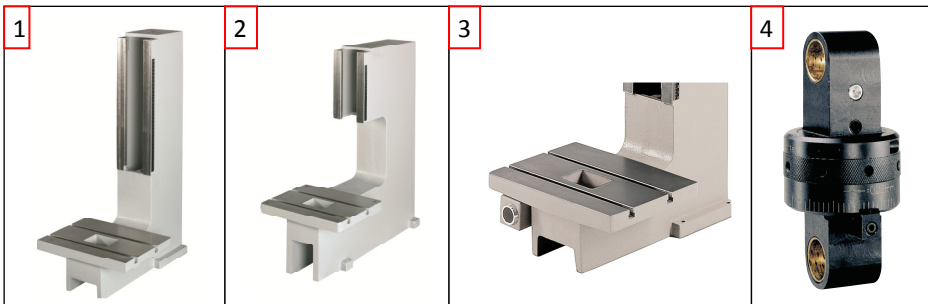

Accessories

1. Extra height frame
2. Extra throat depth frame
3. Additional Start Button
4. Fine Adjustment

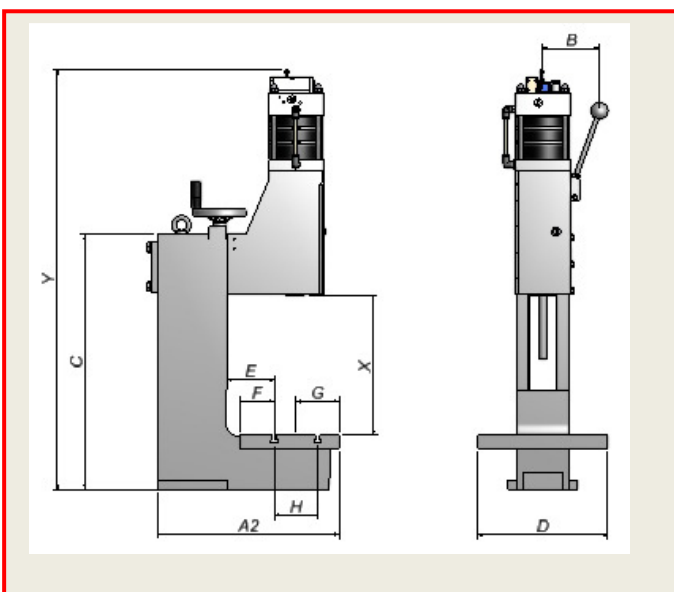

Dimensions	20 kN HKP/L
A2	445
B	130
C	590
D	300
E	160
F	130
G	100
H	100
U	29
X	100 - 320
Y	955 - 988
Ram Location Dia	Ø15 H7
Stroke	6-58
Force at lower position	Max 20kN @7 bar